

brands you trust.



Industrial Diaphragm Valves



Crane ChemPharma & Energy

www.cranecpe.com

OVERVIEW

Pioneers in Diaphragm Valve Technology

Since P.K. Saunders invented the original diaphragm valve in 1928, Saunders® has led the way in providing solutions to industries where flawless operation and resistance to corrosion, abrasion and contamination are imperative. Simplicity of design coupled with more than 85 years of innovation has resulted in the Saunders® diaphragm valve's ability to handle a wider range of fluids than any other valve type. As a result, Saunders® diaphragm valves have gained an excellent reputation for versatility and reliability, establishing a presence in every process industry sector.



Today, Saunders® is an international leader in the design, development and manufacture of diaphragm valves. As part of Crane Co, a diversified global manufacturer of engineered industrial products, Saunders® has a strong worldwide presence via dedicated sales companies and distribution partners.

History of Innovation

Saunders® has led the way in the development of the diaphragm valve to meet the ever increasing demands of industrial applications:

- PTFE and modified PTFE diaphragms
- Glass and fluorocarbon linings
- Non-bonded PTFE diaphragm
- Compact pneumatic actuators
- Three layer diaphragm for corrosive-gas applications
- Introduction of the XA diaphragm (resistant to both chemical and abrasive attack)

A Continuing Story of Success

Millions in service

Saunders® diaphragm valves are used in every process industry. Millions of Saunders® diaphragm valves are currently installed in process plants around the world and they are renowned for versatility and reliability.

Dependable operation

Engineers know they can trust Saunders® Valves. They set the industry standard for dependable, consistent operation, even in the most adverse conditions with years of trouble-free performance.

Customer Service

Customers know they can depend on Saunders® for after sales service and technical support from one of our many locally based sales associates and distribution partners.

The Science Inside

Backed by more than 80 years of experience in polymer technology, Saunders® proudly develops and manufactures its own polymer compounds. It is "The Science Inside™" our valves which sets us apart.

Global Compliance

Saunders® diaphragm valves are fully compliant to all relevant global standards.



Key Diaphragm Valve Features

- 1 **The Science Inside®:** Proprietary diaphragm technology provides unique sealing solution and complete emissions control.
- 2 **Unmatched Expertise & Innovation:** Comprehensive selection of polymers delivers superior corrosion and abrasion resistance for a wide range of demanding applications, since 1928.
- 3 **Efficient Operation:** Top entry design enables in-line maintenance capability to reduce plant down-time.

KEY PRODUCTS

“A Type” Weir Design for Corrosive Media and Utilities

- Versatile and extensively used in industrial applications
- Can handle up to 15% solids (depending on process conditions)
- Perfect valve for on/off or control applications on corrosive processes

KB and K Type Straight Through Designs for Solids Handling

- Smooth, straight-through design
- High flow capacity
- Can handle highly abrasive fluids with up to 100% solids content

WFB for Marine and Fire Applications

- Weir type valve for fire fighting, tank cleaning or wash down on land or sea
- Guaranteed operation even after years of being static
- Fire tested diaphragm

NX Check Valve

- Low pressure and vacuum duties
- Unidirectional full flow design
- Corrosion resistant linings

Actuation - Modular or Compact Actuators

- Different actuator types that cover DN008 (¼") to DN250 (10")
- Wide range of line and operating pressure options
- Conceived to withstand the most adverse conditions

In-house Manufacture of All Diaphragms

- Vulcanized layers with high strength woven reinforcement in elastomer-based diaphragms
- Range of PTFE-type diaphragms for critical applications
- Innovative compounding based on extensive polymer knowledge



“We are pleased to inform that we are using Saunders® in our Runcorn chlor-alkali and chlorine derivatives plants. We are very satisfied with the product’s reliability, low maintenance costs and with the quality of the technical service. We hope to get the same support in all our future supplies/requirements”
INEOS ChlorVinyls (UK)

“We specified Saunders® WFB 65mm nominal bore fire-mains hydrant valves for our ferries and cruise liners. Significant factors behind this choice are the excellent reliability and the low maintenance costs.”
P&O Cruises (UK) Ltd

WHY DIAPHRAGM VALVES?

1 Corrosion Resistance

Saunders® lined valves are the first choice for highly corrosive applications. We offer an extensive range of linings and diaphragms to suit most applications. This wide selection of body lining and diaphragm materials provides an effective and economical solution by eliminating the need for exotic alloys. Our extensive range of valve options include elastomer and fluoropolymer linings, designed especially to combat corrosion.

2 Abrasion Resistance

Saunders® polymer technology provides superior abrasion resistance. The KB straight through valve will handle up to 100% solids and ensure leak-free shut off with a soft rubber diaphragm.

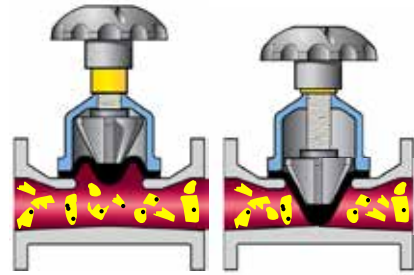

3 Leak Tight

In pressure and vacuum services, Saunders® diaphragm valves deliver 100% leak-tight shutoff in accordance with standards MSS SP-88 and BS EN 12266-1, even after thousands of operations. This reduces processing and handling costs by eliminating emissions commonly associated with other valve designs.

4 Operating Mechanism Isolated from Line Media

All working parts of the valves are isolated from the line media and positive closure is obtained even on frequent cycling or with entrained particulates in the line, unlike other valve types.

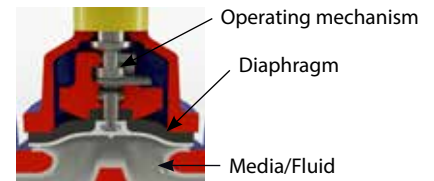

5 Easy Maintenance

A three-part design allows maintenance and actuator retrofitting without removing the valve body from the pipeline. Overall, this results in lower cost of ownership compared to other valve types.



6 Suitable for Control

Throttling and control characteristics are enhanced by a streamlined flow path that is cavity free and provides excellent flow control capabilities.

7 Linear Operation

Linear movement of the valve eliminates the rotational seat wear that is characteristic of quarter-turn valves, resulting in a longer service life and reduced total cost of ownership. This results in a longer service lifetime.



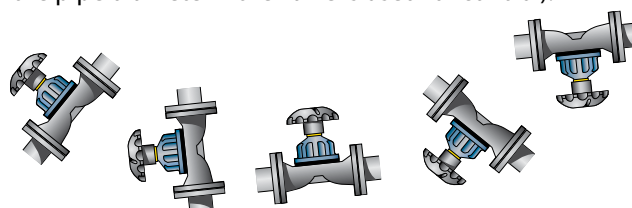

8 Installation Versatility

The Saunders® valve can be installed in any position without affecting its operation. However, we recommend installation to be at least six times the pipe diameter from a bend or pump (ten times the pipe diameter if the valve is used for control).

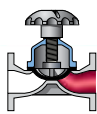

Links to animations depicting the concepts discussed here are available on the Saunders® section of the Crane ChemPharma & Energy website.

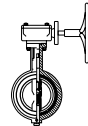
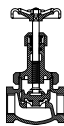
VALVE COMPARISON

Valve/Service Feature	 Diaphragm	 Ball	 Butterfly	 Globe	 Gate	 Lubricated Plug
Leak tight* shut-off against gases, liquids and solids	Green	Yellow	Yellow	Yellow	Yellow	Yellow
Resistance to abrasion and erosion	Green	Yellow	Yellow	Red	Yellow	Yellow
Wide choice of materials to match service conditions	Green	Green	Green	Yellow	Yellow	Yellow
Non-turbulent flow path	Green	Green	Yellow	Red	Green	Green
Low fluid friction loss	Green	Green	Yellow	Red	Green	Green
Resistance to corrosion	Green	Green	Green	Yellow	Yellow	Yellow
Vacuum capability	Green	Green	Yellow	Yellow	Red	Yellow
In-line maintenance, low cost spares	Green	Yellow	Yellow	Red	Red	Yellow
Resistance to seat wear	Green	Red	Red	Green	Yellow	Red
High purity	Green	Yellow	Yellow	Red	Red	Red
Control applications	Green	Yellow	Yellow	Green	Red	Yellow
On/off applications	Green	Green	Green	Yellow	Yellow	Yellow
Temperature range	Yellow	Green	Green	Green	Green	Yellow
Pressure range	Yellow	Green	Green	Green	Green	Green
Weight/size ratio	Yellow	Yellow	Green	Yellow	Yellow	Yellow

Suitable Not Suitable

Saunders® offers a comprehensive range of diaphragm valves for use in any industry. They encompass the full spectrum of corrosive and abrasive applications that require reliable valve operation. Easily maintained to ensure many years of trouble-free operations, Saunders® diaphragm valves have become a standard in industries such as chemical production, mining, water treatment, fertilizers and marine.

*In accordance with standards MSS SP-88 and BS EN 12266-1

APPLICATIONS

CORROSIVE

Corrosion is estimated to cost worldwide industry more than 300 billion dollars every year. Saunders® lined diaphragm valves are the best option to handle these media.

- Chloro-Alkali
- Sulfuric Acid
- Hydrochloric Acid
- Nitric Acid
- Aromatics
- Effluent Treatment
- Potable Water
- Pulp and Paper
- Organics
- Toxic Fluids
- Iron and Steel
- Fine Chemicals

ABRASIVE

Saunders® KB valves are ideally designed for applications requiring a combination of corrosion and abrasion resistance, reliability and long service life.

- Fertilizers
- Titanium Dioxide
- Phosphate
- Copper Mining
- Gold Mining
- Sand
- Coal Slurry
- FGD
- Cement
- Ceramics
- Sewage
- Sugar

GENERAL INDUSTRY

The best solution for a wide range of water, air and gas applications.

- Water demineralization
- Marine
- Vegetable Oils
- Paints
- Fire Fighting
- Tanning
- Oil Production
- Automotive
- Gaseous effluents
- Fuels
- Food & Beverage
- Wastewater
- HVAC
- Compressed air and gases

Type	Applications	Body/Lining	Diaphragm
C	Strong Acids	ETFE, PVDF, PFA, Glass ¹	PTFE
C	Fine Chemicals and Chlor-alkali	Glass ¹ , Wide range of rubbers and plastic linings	Fluoroelastomer, Chlorosulfonated polyethylene, PTFE
C / A	Mineral processing	Butyl, Soft rubber	Butyl, Natural rubber and the Ultimate XA ²
C / A	Gypsum (FGD)	Butyl	Butyl, Ultimate XA ²
C / A	Titanium dioxide	Glass, Butyl, Soft rubber	Butyl, Natural rubber
C / A	Fertilizers	Butyl, Polychloroprene	Butyl, Polychloroprene, Ultimate XA ²
C / A	Pulp & Paper	Glass, Halar, Butyl	EPM, Butyl, Polychloroprene, Ultimate XA ³
A	China clay	Butyl, Soft rubber	Natural rubber, Polychloroprene
G	Water demineralization, desalination, & sewage treatment	Hard rubber, Soft rubber, Butyl	EPM, Butyl, Polychloroprene, Butadiene Acrylonitrile
G	Marine, fire fighting ³	SG Iron, Gunmetal	Chlorosulfonated polyethylene (fabric reinforced)
G	HVAC, utilities (air, water and gas lines) ⁴ , drinking water	Screwed/Flanged unlined valves in iron, stainless steel or gunmetal	EPM, Butyl, Polychloroprene

C = Corrosive, **A** = Abrasive, **G** = General Industry

¹ Glass is not suitable for applications with thermal cycling. Chemical etching may occur when in contact with hydrofluoric acid or highly concentrated alkali solutions. Please contact Saunders® for precise recommendations.

² The Ultimate XA Diaphragm was specially developed for highly corrosive and abrasive applications.

³ Used primarily as water hydrant valves.

⁴ Used in copper or stainless steel piping in water, oxygen and other gases.

POLYMER SCIENCE

At Saunders®, we apply rigorous quality control measures at every manufacturing step of our polymer materials. For many years, we have increased our expertise and accumulated experience in the production of our own **diaphragms** and valve **linings**. As a result, our valves can handle the most challenging fluids with total security. The name Saunders® is synonymous with innovation, continuous product development and the highest standards of quality control.



A type, butyl rubber diaphragm



PTFE diaphragm with butyl rubber backing



KB type, soft natural rubber diaphragm



214K diaphragm for high performance in chlorine applications

Fitments Features



Rubber diaphragms Screw fitment



PTFE diaphragms Bayonet fitment

BEST MATERIALS ■ STRINGENT QUALITY CONTROLS ■ RELIABILITY, LONG LIFE AND SIMPLIFIED MAINTENANCE

Diaphragm Construction



- Appropriate choice of the finest raw materials and fabric reinforcements.
- Diaphragms constructed with multi-layers of rubber and reinforcement for maximum performance and durability.
- Studs attached with bonding adhesive and mechanical anchorage.
- Dual sealing ribs (across the weir and around the diaphragm periphery) for enhanced leak tight sealing capabilities and lower closure torque.
- Optimised thickness of diaphragms for superior flexing properties.

PTFE Diaphragm



Two -piece diaphragm construction - PTFE face, with reinforced rubber backing - to increase pressure rating and durability.

SUPPORTING DATA AND CERTIFICATIONS

Saunders® Data Sheets

Digital copies of technical data sheets, which provide detailed information on the Saunders® IDV range, can assist with valve selection and are available upon request. Contact your local sales office or distributor for more details on how to obtain the data sheet package.



Data sheet index and typical valve information

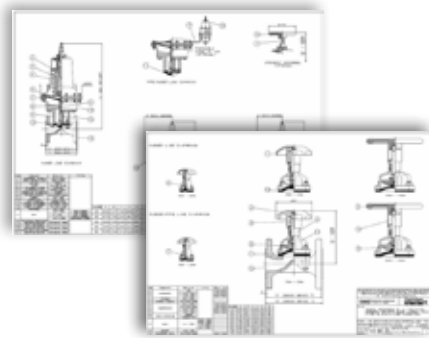

Example of 2D Drawings available on Saunders® website.

Material Compatibility Database

Saunders® has a database of over 800 chemicals, which can be used to aid lining and diaphragm material selection. By selecting the process fluid, temperature and concentration, the suitable material options are identified.



Screenshot of Saunders® Material Compatibility Database

Saunders® 2D Drawings

A library containing technical drawings of the Saunders Industrial Diaphragm Valve and Actuator range is available online at www.saundersdrawings.com.

Quality Statements And Approvals

CERTIFIED QUALITY FROM SAUNDERS®

- Quality Management system registered to ISO 9001 standard in which our R&D and manufacturing process are optimized to maintain our product quality and service
- Certified compliance to the European Pressure Equipment Directive 97/23/EC, authorizing Saunders® to CE mark relevant valve products
- TUV-Merkblatt HPO Qualification for our product manufacturing and certification
- International product approval from authorities such as Bureau Veritas, Lloyds, ABS, RINA and TSG
- Polymer materials certified as meeting the requirements of FDA, USP and WRAS

EXAMPLES OF PRODUCT AND SYSTEM APPROVALS

- ISO 9001
- PED 97/23/EC
- WRAS (Water Regulations Advisory Scheme)
- Lloyds Register of Shipping
- Bureau Veritas
- ATEX Directive (94/9/EC)
- Food & Drug Administration (FDA)
- United States Pharmacopeia (USP)
- Registro Italiano Navale (RINA)



Compliance WITH
FDA Code 21
TNO CERTIFICATION 3A
cGMP USP 23

A TYPE FEATURES

Original Saunders® Design

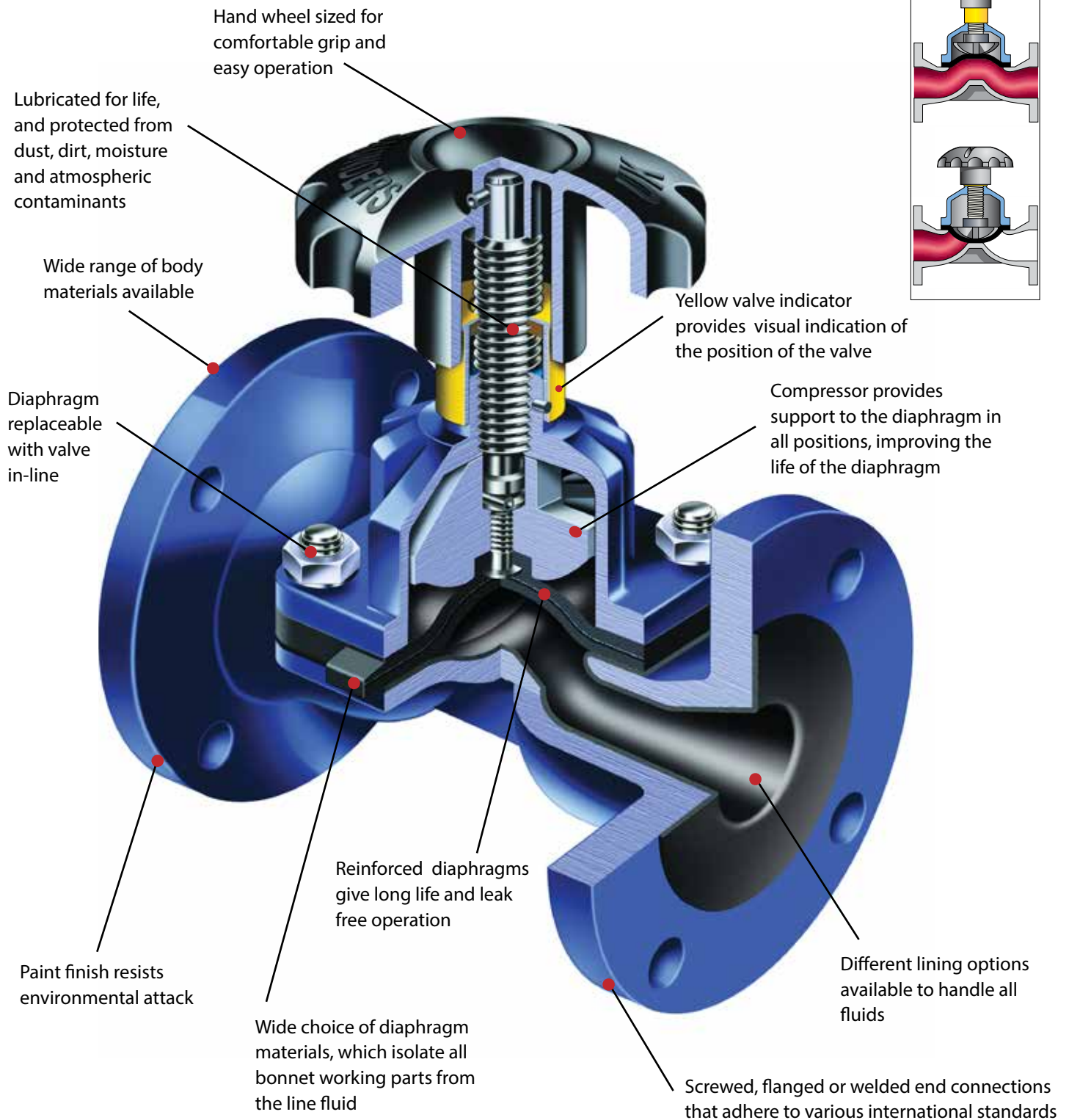

**Saunders® A type Diaphragm Valve:
the valve of choice to handle highly corrosive media**

A TYPE BODY

Lined and Unlined Options

Our metal bodies provide simultaneous mechanical support for the lining and protection against Ultraviolet (UV) attack. The nominal bore thicknesses of Saunders® linings range from 1 to 5.5 mm, depending on lining material and valve size: glass 1 mm, rubber 2-4.5 mm and plastic 4-5.5 mm.

Unlined Bodies

Material	Connection	Standard	Material Grade*	Size	Temperature
Cast Iron	Flanged	BS EN1561	GJL-250	½"-20" DN15-DN500	14°F to 347°F -10°C to 175°C
	Screwed	BS EN1563	GJS-450-10	¼"-2" DN8-DN50	14°F to 347°F -10°C to 175°C
Flanged	GJS-400-18 ¹		½"-14" D15-DN350	-10°C to 175°C	
Cast Steel	Flanged	ASTM A216	WCB	½"-10" DN15-DN250	-22°F to 347°F -30°C to 175°C
Gunmetal	Screwed	BS EN1982	CC491K-GS	¼"-3" DN8-DN80	-22°F to 347°F -30°C to 175°C
	Flanged		CC492K-GS	½"-8" DN15-DN200	-30°C to 175°C
Stainless Steel	Screwed	BS EN10283	1.4408 ²	¼"-3" DN8-DN80	-22°F to 347°F -30°C to 175°C
	Flanged			½"-8" DN15-DN200	-30°C to 175°C

¹ For some sizes GJS-400-18-LT grade is available with a low temperature limit of -20°C (-4°F)

² Replaces the standard BS3100 316C16

* Please contact Saunders® for information on comparable/equivalent material grades.

Lined Options - Flanged Bodies Only

Lining	Body Material	Size	Temperature
PFA	SG Iron	½"-8" DN15-DN200	14°F to 347°F -10°C to 175°C
ETFE	SG Iron	½"-6" DN15-DN150	14°F to 302°F -10°C to 150°C
PVDF	SG Iron	¾"-6" DN20-DN150	14°F to 257°F -10°C to 125°C
PP	SG Iron	¾"-6" DN20-DN150	14°F to 185°F -10°C to 85°C

Glass	Body Material	Size	Temperature
	Cast Iron	½"-8" DN15-DN200	14°F to 347°F -10°C to 175°C

Butyl (Isobutylene Isoprene)	Cast Iron	¾"-20" DN20-DN500	14°F to 230°F -10°C to 110°C
	SG Iron		-22°F to 230°F -30°C to 110°C
Neoprene (Polychloroprene)	Cast Steel	¾"-20" DN20-DN500	14°F to 221°F -10°C to 105°C
	Cast Iron		-22°F to 221°F -30°C to 105°C
	SG Iron		-30°C to 105°C
HRL (Hard Natural Rubber)	Cast Iron	¾"-20" DN20-DN500	14°F to 185°F -10°C to 85°C
	SG Iron		-22°F to 185°F -30°C to 85°C
	Cast Steel		-30°C to 85°C

Standard material grade fasteners:

Stainless steel fasteners - All stainless steel, plastic lined and glass lined valves

Aluminium Bronze fasteners - Gunmetal flanged valves

Carbon Steel fasteners - All remaining valves.

Special material grade fasteners available upon request

Plastic Lining



PFA Perfluoroalkoxy – Excellent suitability for concentrated strong acids at high temperature, aromatics, aliphatic and chlorinated solvents. (White)



ETFE Ethylene Tetrafluoroethylene – Suitable for strong acids, salts in water, solvents at medium temperature. ETFE has the highest abrasion resistance of all the fluorocarbon linings. (Red)



PP Polypropylene – Economic solution for mineral acids, salts in water, de-ionised water and effluent treatment chemicals. (Light grey)



PVDF Polyvinylidene Fluoride – Suitable for mineral acids, salts in water, water and effluent treatment, additionally it is the best solution for wet chlorine gas or chlorine in water. (Black)

Glass Lining



Used in many different applications, including strong acids. Very high corrosion and abrasion resistance within a wide range of temperature. *Note that glass is not suitable for applications where thermal cycling occurs.* (Blue)

Corrosion & Chemical Resistance

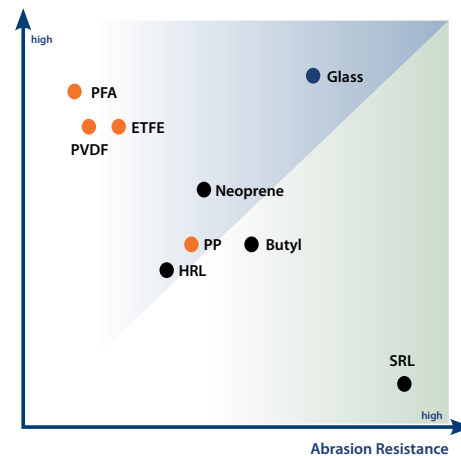

Rubber Lining



HRL Hard Natural Rubber (Ebonite) – Used for salts in water, diluted acids, de-ionised water, plating solutions and potable water. HRL has better chemical resistance than SRL. (Black)

Butyl Isobutylene Isoprene – Great for corrosive & abrasive slurries, and acidic slurries. Additional applications are salts in water, dilute acids and alkalis, and lime. (Black)

Neoprene Polychloroprene – Perfect solution for a combination of abrasive slurries containing hydrocarbons, sludge oils and also sea water. (Black)

The temperature ranges above are given for general reference purposes only. Service conditions, such as media being handled and concentration of solids, will determine the highest possible working temperature. Additionally, the performance of the valve will also depend on the diaphragm material.

DIAPHRAGM VALVES TYPE A DIAPHRAGM

A Type Diaphragm

Diaphragm	Composition	Size	Temperature
425	EPM (Ethylene Propylene)	All Sizes	-40°F to 226°F -40°C to 130°C
300	Butyl (Isobutylene Isoprene)	All Sizes	-40°F to 226°F -40°C to 130°C
237	CSM (Chlorosulfonated Polyethylene)	All Sizes	14°F to 212°F -10°C to 100°C
XA	EPDM (Ethylene Propylene Diene)	All Sizes	-40°F to 266°F -40°C to 130°C
HT	Neoprene (Polychloroprene)	All Sizes	-22°F to 212°F -30°C to 100°C
226	FKM (Fluoroelastomer)	All Sizes	23°F to 302°F -5°C to 150°C
C	Nitrile (Butadiene Acrylonitrile)	All Sizes	-4°F to 212°F -20°C to 100°C
Q	Natural Rubber	All Sizes	-58°F to 212°F -50°C to 100°C

214/300	PTFE/Butyl	¼"-10" DN8-DN250	-4°F to 302°F -20°C to 150°C
214/425	PTFE/EPM	¼"-10" DN8-DN250	-4°F to 320°F -20°C to 160°C
214/226	PTFE/FKM	¼"-10" DN8-DN250	23°F to 347°F -5°C to 175°C
214S/425	TFM/EPM	¼"-6" DN8-DN150	-4°F to 320°F -20°C to 160°C
214K/425	PTFE/PVDF/EPM	½"-6" DN15-DN150	-4°F to 212°F -20°C to 100°C

Diaphragm Identification

In the range of PTFE diaphragms, Saunders offers both moulded open and closed options for your convenience. The 214S is available as moulded closed and was designed specifically to reduce polymeric creep, therefore increasing the sealing properties and life of the diaphragm.

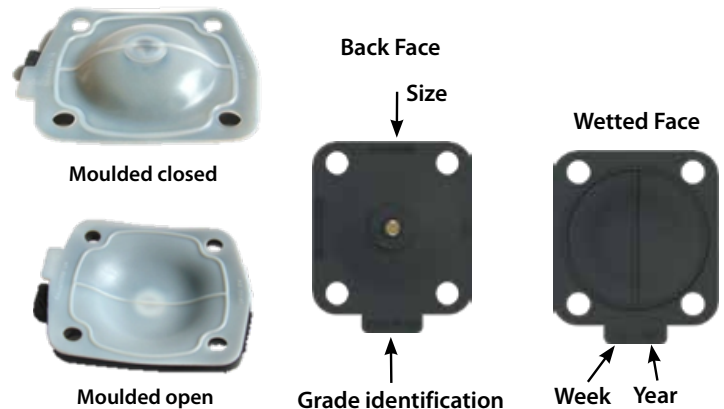

PTFE Diaphragm

214/300 - Used in strong acids and alkalis, and salts in water at high temperature. Sulfuric acid is a good example with temperatures up to 110°C (230°F) and concentrations up to 96 %.

214/425 - Typical applications are strong acids, alkalis and salts in water at high temperature. Constant steam is also another important application.

214/226 - Strong acid, diluted chlorine, bromine solutions at low concentration.

214S/425 - Strong acids, alkalis and salts in water at high temperature. Constant steam applications where the valve is mainly closed (diaphragm is moulded closed).

214K/425 - Three layer diaphragm with PTFE/PVDF/425, the best option for chlorine, bromine gas and chlorinated solutions.

425 - Salts in water, acids and alkalis, ozone, water, intermittent steam. Great solution for food and beverages applications. FDA and USP approved¹.

300 - Chemicals, diluted acids and alkalis, drinking water. Additional abrasive applications like phosphoric acid in low concentrations. FDA, USP and WRAS approved¹.

237 - The best solution for sodium hypochlorite. Great with strong acids and low concentration chlorine gas. It is also oil resistant.

XA - Specifically designed for both abrasive and corrosive applications such as phosphoric acid, metal treatment, mining applications.

HT - Suitable for abrasive slurries containing hydrocarbons.

226 - Great solution for hydrogen at high temperature, concentrated acids, aromatic solvents, low concentrated chlorine solutions, ozone, unleaded petroleum.

C - Lubricating oil, cutting oils, paraffin, animal and vegetable oils, aviation kerosene at low temperatures. Cv is ideal for vacuum applications, where oils are present, e.g. (compressed air, acetylene gas, LPG).

Q - Salts in water, diluted acids and alkalis, and abrasive applications.

Corrosion & Chemical Resistance

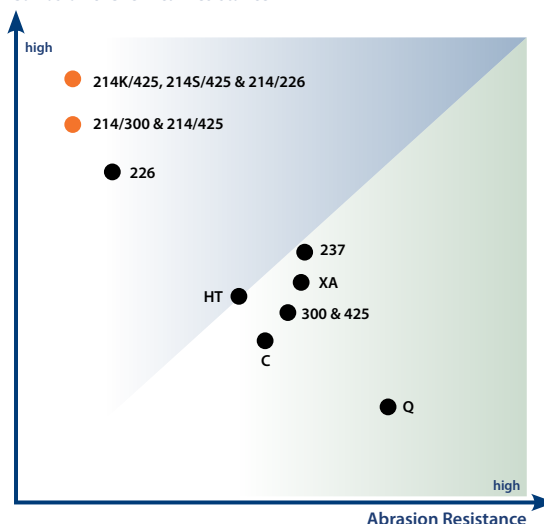

¹ FDA - Food and Drug Administration
USP - United States Pharmacopeia
WRAS - Water Regulations Advisory Scheme

All rubber diaphragms have threaded brass fittings, except vacuum diaphragm (Cv, 300v, 425v), which have steel fittings. PTFE diaphragms have a stainless steel bayonet fitting.

A TYPE - TOP WORKS

Standard Range

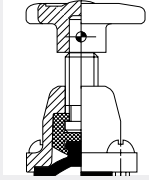

Rising handwheel (2 bolt)
DN8 - DN10
1/4" - 3/8"

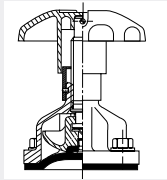

Cast iron bonnet with rising plastic handwheel
DN15 - DN50
1/2" - 2"

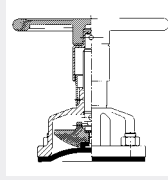

Cast iron bonnet with rising metal handwheel
DN15 - DN150
1/2" - 6"

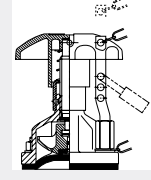

Rising handwheel with indicator (simple padlocking)
DN15 - DN150
1/2" - 6"

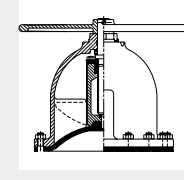

Standard non-rising handwheel without indicator
DN200 - DN350
8" - 14"



Non-rising handwheel with indicator
DN200 - DN350
8" - 14"

High Performance

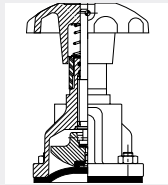

Fluoroelastomer sealed with padlocking
DN15 - DN150
1/2" - 6"

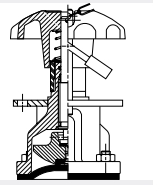

Fluoroelastomer sealed bonnet
DN15 - DN150
1/2" - 6"

Saunders® Actuation

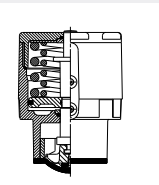

EC actuators (spring close/spring open/double acting)
DN8 - DN50
1/4" - 2"

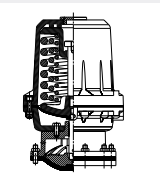

ECX actuators (spring close/spring open/double acting)
DN65 - DN150
2 1/2" - 6"

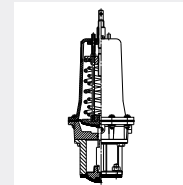

ESM/ES actuators (spring close/spring open/double acting)
DN15 - DN250
1/2" - 10"

Note: Designs may vary across size range

For more details of actuation see pages 17-20

Manual Valves Working Pressure & Temperature

Maximum manual working pressures for Saunders® A Type Diaphragm valves. For actuated valves, please refer to the appropriate datasheets

Bonnet pressure limits

Diaphragm	Pressure (bar/psi)					
	Rubber		PTFE			
Handwheel	Rising	Non-Rising	Rising	Non-Rising		
Size (DN/in)						
8	1/4"	16	232	10	145	
10	3/8"	16	232	10	145	
15	1/2"	16	232	10	145	
20	3/4"	16	232	10	145	
25	1"	16	232	10	145	
32	1 1/4"	16	232	10	145	
40	1 1/2"	16	232	10	145	
50	2"	16	232	10	145	
65	2 1/2"	10	145	10	145	
80	3"	10	145	10	145	
100	4"	10	145	10	145	
125	5"	10	145	10	145	
150	6"	10	145	7	102	
200	8"		6	87	6	87
250	10"		5	73	5	71
300	12"		4	58		
350	14"		3.5	51		

Note: For temperature rating, please refer to adjacent graphs.

All Saunders® valves are pressure tested in accordance with standard BS EN 12266-1.

- Shell test: 1.5 times maximum rated working pressure
- Seat test: 1.1 times maximum rated working pressure

A Type Body Temperature/Pressure Relationship Cast Iron and SG Iron

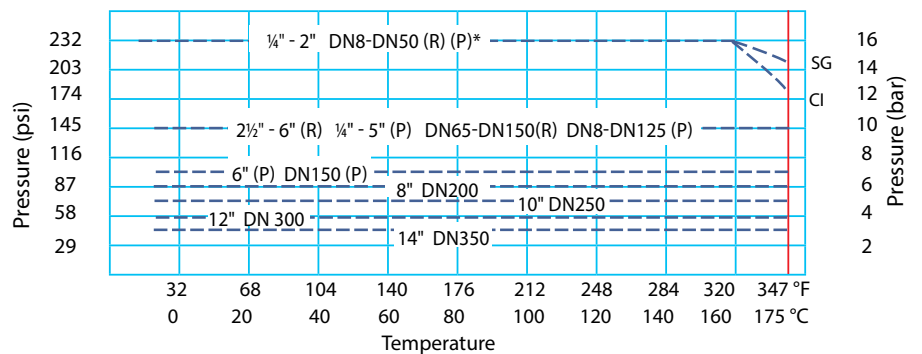

Carbon Steel, Stainless Steel & Gunmetal

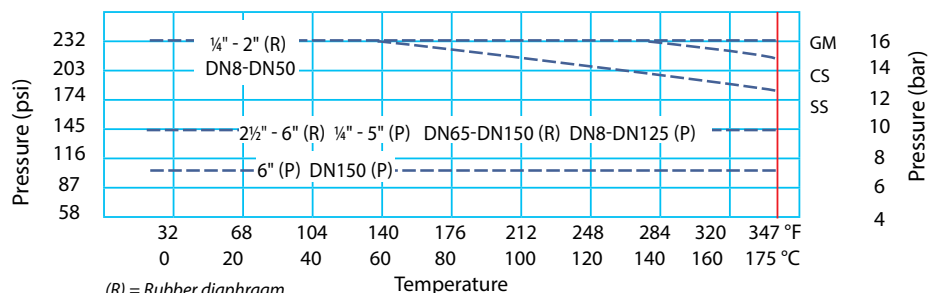

(R) = Rubber diaphragm
(P) = PTFE diaphragm
* 2145 Moulded closed version only.

KB/K TYPE – FEATURES

Saunders® KB and K Design

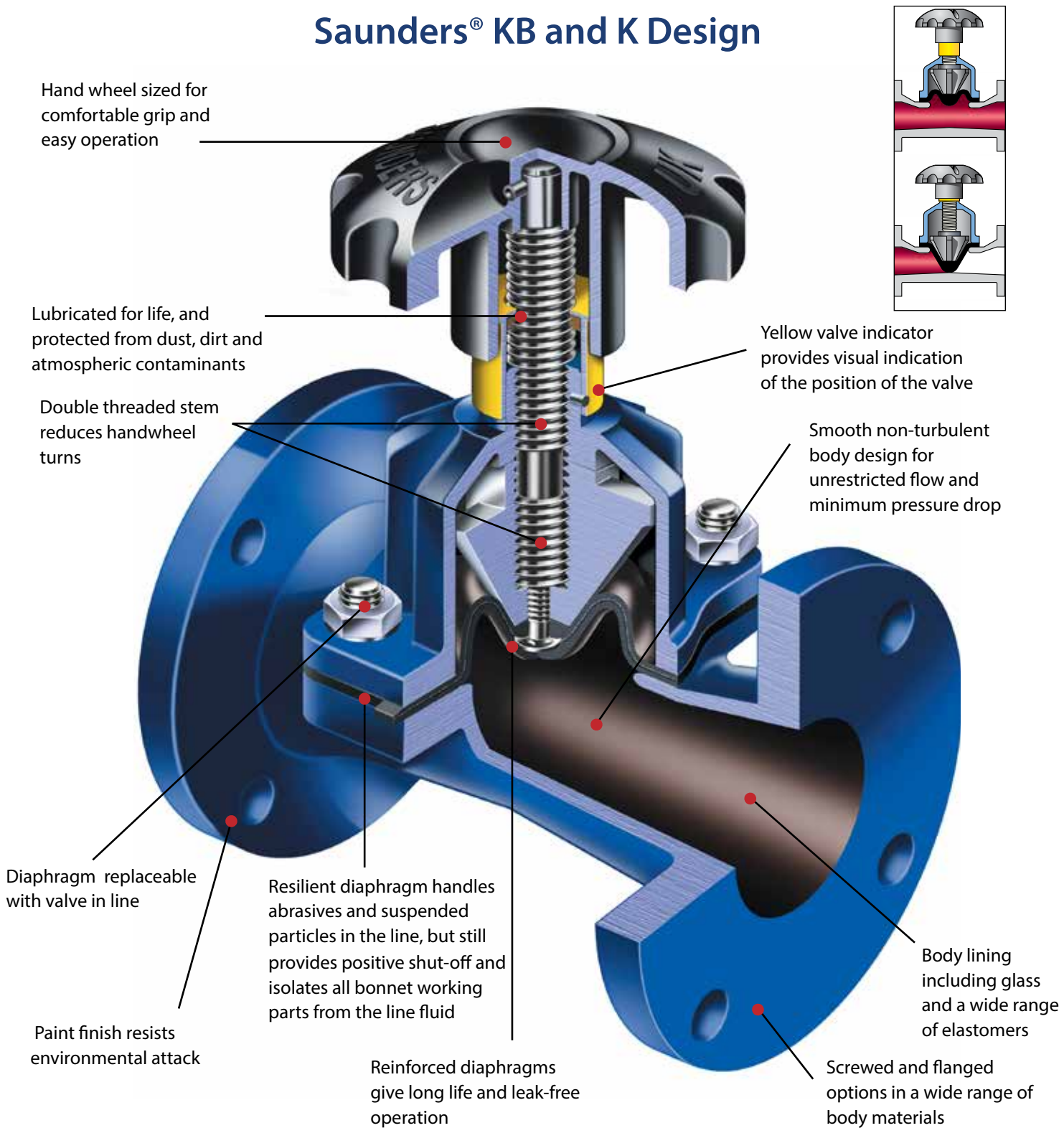

**Saunders® KB and K type (higher flow) valves:
the choice for corrosive slurry applications**

KB/K TYPE - BODY

Lined and Unlined Options

Saunders® full bore KB type diaphragm valves, with their smooth non-turbulent body design, have proven to be outstanding in resisting the erosion effect of abrasive media, providing low pressure drop and high flow characteristics.

Unlined Bodies

Material	Connection	Standard	Material Grade*	Size	Temperature
Cast Iron	Screwed	BS EN1561	GJL-250	½"-2" DN15-DN50	14°F to 347°F -10°C to 175°C
	Flanged			½"-14" DN15-DN350	
SG Iron	Screwed	BS EN1563	GJS-450-10	¼"-2" DN8-DN50	14°F to 347°F -10°C to 175°C
	Flanged		GJS-400-18 ¹	½"-14" DN15-DN350	
Gun Metal	Screwed	BS EN1982	CC491K-GS	½"-2" DN15-DN50	-22°F to 347°F -30°C to 175°C
	Flanged		CC492K-GS	½"-4" DN15-DN100	
Stainless Steel	Flanged	BS EN10283	1.4408 ²	½"-10" DN15-DN250	-22°F to 347°F -30°C to 175°C

¹ For some sizes GJS-400-18-LT grade is available with a low temperature limit of 20°C (-4°F)

² Replaces the standard BS3100 316C16

* Please contact Saunders® for information on comparable/equivalent material grades.

Standard material grade fasteners:

Stainless steel fasteners - All stainless steel, plastic lined and glass lined valves

Aluminium Bronze fasteners - Gunmetal flanged valves

Carbon Steel fasteners - All remaining valves.

Special material grade fasteners available upon request

The flexible diaphragms ensure consistent leak tightness even when solids, powders and dry media are present. The wide range of lining materials make the valve suitable for many corrosive/abrasive applications up to a maximum pressure of 10 bar (145 psi).

Lined Options - Flanged Bodies Only

Lining	Body Material	Size	Temperature
Butyl (Isobutylene Isoprene)	Cast Iron	1"-14" DN25-DN350	14°F to 230°F -10°C to 110°C
	SG Iron		-22°F to 230°F -30°C to 110°C
	Cast Steel		
Neoprene (Polychloroprene)	Cast Iron	1"-14" DN25-DN350	14°F to 221°F -10°C to 105°C
	SG Iron		-22°F to 221°F -30°C to 105°C
	Cast Steel		
Hard Natural Rubber (Ebonite)	Cast Iron	1"-14" DN25-DN350	14°F to 185°F -10°C to 85°C
	SG Iron		-22°F to 185°F -30°C to 85°C
	Cast Steel		
SRL (Soft Natural Rubber)	Cast Iron	1"-14" DN25-DN350	14°F to 185°F -10°C to 85°C
	SG Iron		-22°F to 185°F -30°C to 85°C
	Cast Steel		

Glass	Cast Iron	½" - 6" DN15-DN150	14°F to 347°F -10°C to 175°C
-------	-----------	-----------------------	---------------------------------

Glass Lining

Used in many different applications, including strong acids, salts and halogenated gases. Superior corrosion and abrasion resistance within a wide range of temperatures and concentrations. *Note that glass is not suitable for applications where thermal cycling occurs.* (Blue)

Rubber Lining

Butyl Isobutylene Isoprene — Great for corrosive and abrasive slurries, and acidic slurries. Additional applications are salts in water, dilute acids and alkalis, and lime. WRAS approved. (Black)

Neoprene Polychloroprene — Perfect solution for a combination of abrasive slurries containing hydrocarbons, sludge oils and also sea water. (Black)

Corrosion & Chemical Resistance

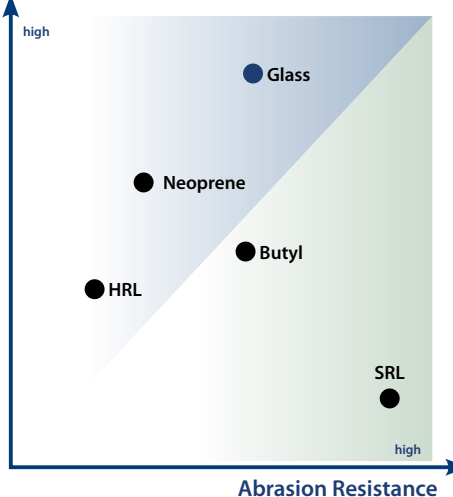

Rubber Lining

HRL Hard Natural Rubber (Ebonite) — Used for salts in water, diluted acids, de-ionised water, plating solutions and potable water. HRL has better chemical resistance than SRL. (Black)

SRL Soft Natural Rubber — High abrasion resistance on powders, abrasive slurries, clays, coal dust, dry fertilizers, gypsum, as well as titanium dioxide and sewage. (Brown)

The temperature ranges above are given for general reference purposes only. Service conditions, such as media being handled and concentration of solids will determine the highest possible working temperature. Additionally, the performance of the valve will also depend on the diaphragm material.

The nominal bore thicknesses of Saunders® linings range from 1 to 5.5 mm, depending on lining material and valve size: glass 1 mm, rubber 2-4.5 mm and plastic 4-5.5 mm.

KB/K TYPE – DIAPHRAGM

Many factors can accelerate the aging of polymer compounds. Temperature and abrasion have a significant impact on the effect of chemicals on rubber compounds. At Saunders®, we are proud of our core competence, the in-house manufacture of Saunders® diaphragms. Our expertise in polymer science assures the best range of diaphragms to suit the most challenging duties with total security. This explains why Saunders® diaphragms are a synonym of longer life, reduced maintenance and higher plant operating efficiencies.

Diaphragm Identification

Energising ribs allow efficient shut-off in wide-bore applications

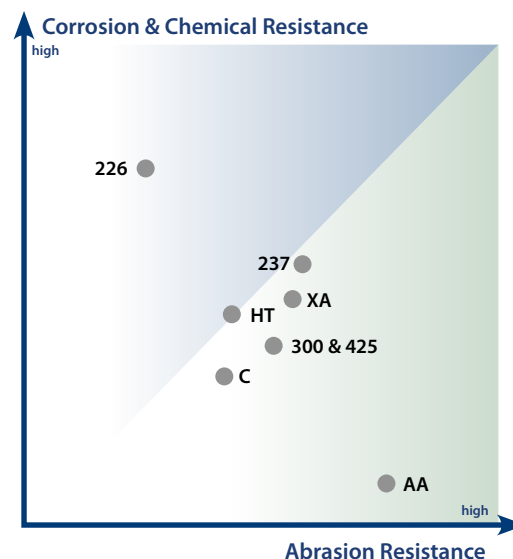
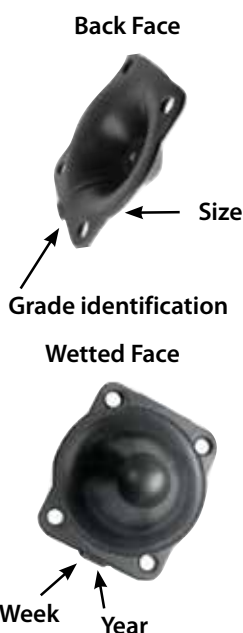

Rubber Diaphragm

226 - Great solution for hydrogen at high temperature, concentrated acids, aromatic solvents, low concentrated chlorine solutions, ozone, unleaded petroleum.

300 - Chemicals, diluted acids and alkalis, drinking water. Additional abrasive applications like phosphoric acid in low concentration. FDA, USP and WRAS approved¹.

HT - Suitable for abrasive slurries containing hydrocarbons.

425 - Salts in water, acids and alkalis, ozone, water, intermittent steam. Great solution for food and beverages applications. FDA and USP approved¹.

237 - The best solution for sodium hypochlorite. Great with strong acids and low concentration chlorine gas. It is also oil resistant.

XA - Specifically designed for both abrasive and corrosive applications such as phosphoric acid, metal treatment and mining applications.

C - Lubricating oil, cutting oils, paraffin, animal and vegetable oils and aviation kerosene at low temperatures.

AA - Excellent choice on abrasive applications such as slurries. The diaphragm has a light brown colour, and is sulfur cured.

KB/K Type Diaphragm

Diaphragm	Composition	Size	Temperature
226	FKM (Fluoroelastomer)	1/2" to 12" DN15-DN300	23 °F to 302 °F -5 °C to 150 °C
425	EPM (Ethylene Propylene)	All Sizes	-40 °F to 226 °F -40 °C to 130 °C
AA	Natural Rubber	All Sizes	-40 °F to 194 °F -40 °C to 90 °C
HT	Neoprene (Polychloroprene)	All Sizes	-22 °F to 212 °F -30 °C to 100 °C
237	CSM (Chlorosulfonated Polyethylene)	All Sizes	14 °F to 212 °F -10 °C to 100 °C
300	Butyl (Isobutylene Isoprene)	All Sizes	-40 °F to 266 °F -40 °C to 130 °C
C	Nitrile (Butadiene Acrylonitrile)	All Sizes	-4 °F to 212 °F -20 °C to 100 °C
XA	EPDM (Ethylene Propylene Diene)	All Sizes	-40 °F to 266 °F -40 °C to 130 °C

¹ FDA - Food and Drug Administration USP - United States Pharmacopeia
WRAS - Water Regulations Advisory Scheme

KB/K TYPE – TOP WORKS

Top Works

Standard Range

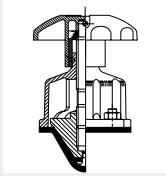

Standard plastic rising handwheel with indicator
DN15 - DN50
½" - 2"

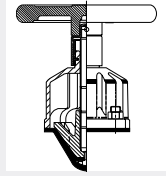

Metal rising handwheel with indicator
DN15 - DN150
2½" - 6"

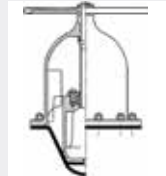

Standard non-rising handwheel without indicator
DN200 - DN350
8" - 14"



Non-rising handwheel with indicator
DN200 - DN300
8" - 12"

High Performance

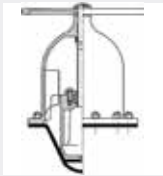

Non-rising handwheel (fluoroelastomer sealed)
DN15 - DN300
½" - 12"

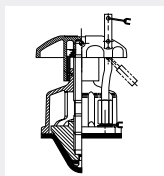

Rising handwheel with indicator (simple padlocking)
DN15 - DN150
½" - 6"

Saunders® Actuation



ESM/ES actuators (spring close/ spring open/double acting)
DN15 to DN250
½" to 10"

For more details of actuation see pages 17-20

Manual Valves Working Pressure & Temperature

Maximum manual working pressures for Saunders® KB Type Diaphragm valve. For actuated valves, please refer to the appropriate datasheets.

Size (DN)	Pressure (bar)	
	Rising handwheel	Non-Rising handwheel
15	10	145
20	10	145
25	10	145
32	10	145
40	10	145
50	10	145
65	10	145
80	10	145
100	10	145
125	6	87
150	6	87
200	-	3.5 51
250	-	3.5 51
300	-	3.5 51
350	-	1.5 22

All Saunders® valves are pressure tested in accordance with standard BS EN12266-1.

- Shell test: 1.5 times maximum rated working pressure
- Seat test: 1.1 times maximum rated working pressure

KB Type Valve Temperature/Pressure Relationship*

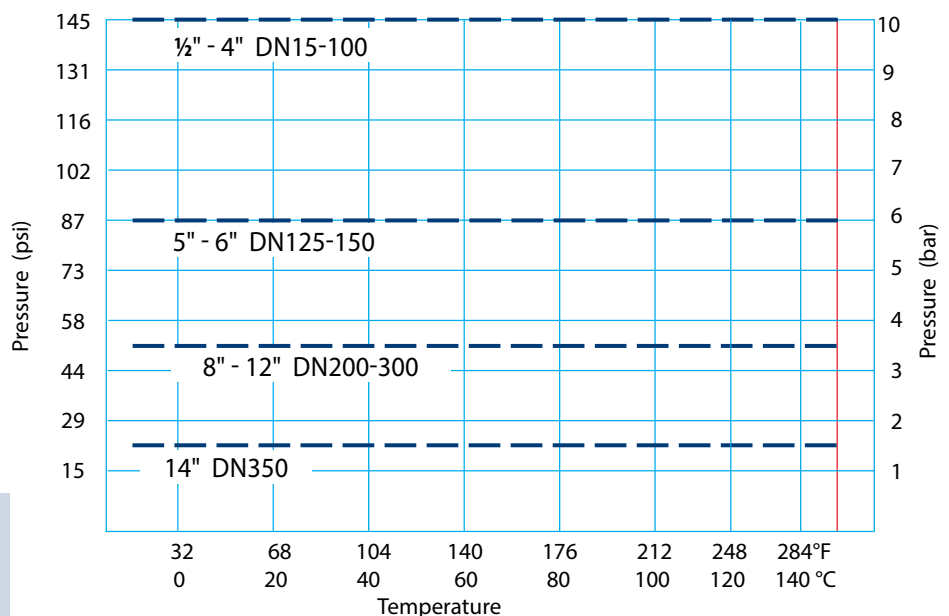

* For K Type valves, refer to one size larger KB valve.

ACTUATION - ES MODULAR DESIGN

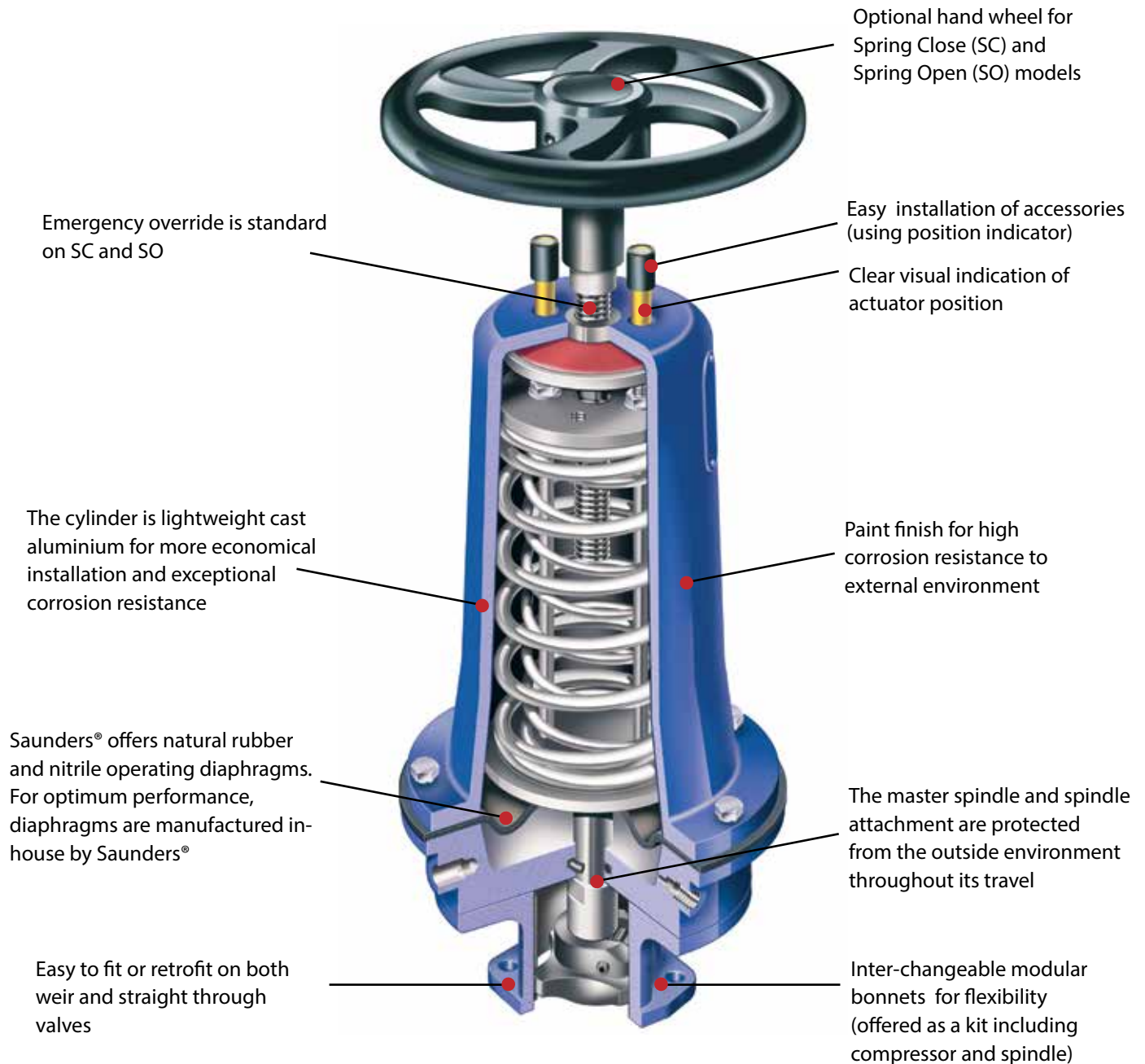

Wide range of actuators that provide reliable remote control

ACTUATION - MODEL RANGE AND MODES OF OPERATION

When manual operation is inadequate or inconvenient, Saunders® offer a variety of actuators covering valve sizes up to DN250 (10"), for different line and operating pressure options. We offer three different actuators, designed for various characteristic performances.

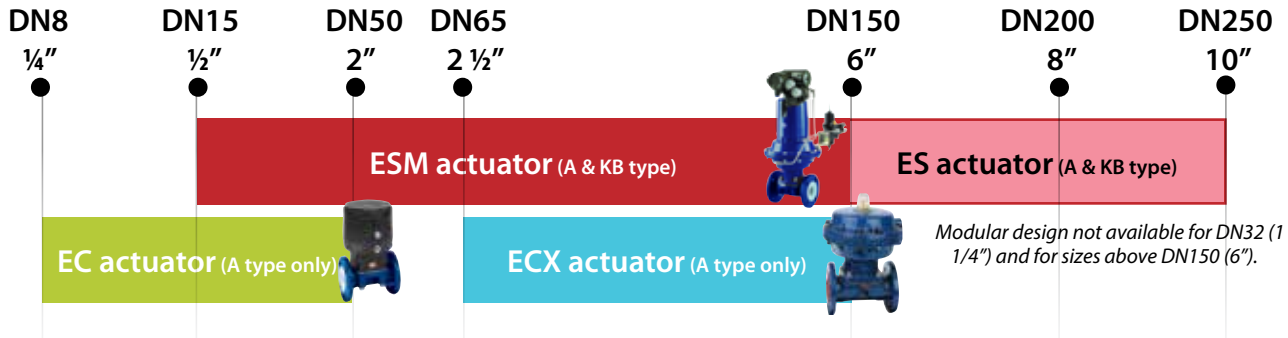

EC	ECX	ES Modular
<ul style="list-style-type: none"> ❶ Compact piston style actuator ❷ Spring packs to suit pressure requirements ❸ Polyethersulfone (PES) bonnet ❹ Versatile and robust design ❺ Temperature range of -10 to 100°C (14 to 212°F) ambient (autoclave maximum 150°C/302°F) 	<ul style="list-style-type: none"> ❶ Diaphragm operated actuator, a compact extension to the EC size range ❷ Comprehensive spring packs for a wide range of pressures ❸ Full range of accessories ❹ Light weight silicon aluminium housings ❺ Durable paint coating for environmental protection 	<ul style="list-style-type: none"> ❶ Diaphragm operated actuator, modular design for flexibility ❷ Adjustable spring tension to optimize closure force and maximize diaphragm life ❸ Full range of accessories ❹ Light weight silicon aluminium housings ❺ Durable paint coating for environmental protection

	Spring Close (SC)	Spring Open (SO)	Double Acting (DA)
Mode of operation	Closes the valve against line pressure in the event of failure (or intended shutoff) of operating pressure to the actuator.	Opens the valve to allow line fluid to flow in the event of failure (or intended shutoff) of operating pressure to the actuator.	Operating pressure opens and closes the valve. Requires a lock up valve to retain the position preceding the failure.
Normal use	When valve is usually in the closed position (to avoid using a constant supply of operating pressure).	When valve is usually in the open position (to avoid using a constant supply of operating pressure).	When a failsafe mode is not required.

ACTUATION ACCESSORIES

Accessories								
Model	Size Range	Valve type	Material	Solenoid	Switchbox	Positioner	Air Filter	Handwheel
ES	DN15-DN250 1/2" - 10"	A, KB	SiAl ¹	✓	✓	✓	✓	✓
EC	DN8-DN50 1/4" - 2"	A	PES ²	✓	✓	✓	✗	✗
ECX	DN65-DN150 2 1/2" - 6"	A	SiAl ¹	✓	✓	✗	✓	✗

¹ SiAl – Silicon-Aluminium

² PES – Polyethersulfone

✓ Available

✗ Unavailable



007 Switchbox

Modular switch-boxes are available for the ES Modular actuator range.

Offering a wide range of both mechanical and proximity switches as well as other options, i.e. ASi-interface.



Shown mounted to ESM Actuator

ES Positioner

Provides precise control of the flow through the valve. This long life corrosion resistant range suits a wide variety of applications with reliability and accuracy. Available as pneumatic, electro-pneumatic, intrinsically safe and explosion proof, together with a variety of feedback options. A digital option is also available.

Opti-SET

Economical, compact and lightweight switchbox suitable for the EC actuator. Self setting, which minimizes validation/set-up-time, it is available with mechanical or proximity switches including an intrinsically safe option.



Mini Positioner

For control application using an EC actuated valve, Saunders® offers pneumatic, electropneumatic and digital inputs with sensor feedback option and linear mounting design providing a compact control solution.

Saunders® I-VUE

The Saunders® I-VUE is a compact intelligent valve sensor that provides accurate and reliable valve position feedback. It is suitable for EC or ECX actuated valves. Key Features and Benefits:

- Available as Point-to-Point or with network capabilities (ASi and DeviceNet)
- Highly accurate electronic sensing technology to continuously monitor valve position.
- Self Setting (without entry) feature that facilitates setting and programming of switch without opening the enclosure.



MODULE Switchbox

This module switchbox option is available for EC and ECX actuator ranges. The switchbox offers a wide range of mechanical and proximity sensors with space for up to 4 switches, integral solenoid valve and ASi interface (which can be retrofitted).



Solenoid valves

A wide range of locally mounted banjo solenoid valves can be fitted to the Saunders® actuator range with a manual override position and various hazardous area classifications. The solenoid range is designed to cover all requirements.

Other control options available upon request. Please, contact Saunders® for more information

CATALOGUE CODES

A & KB Type Valves

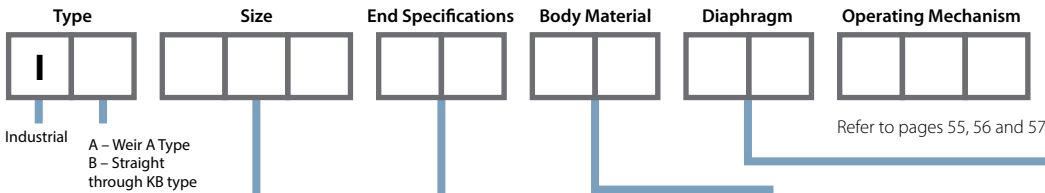

Size	
DN8	008
DN10	010
DN15	015
DN20	020
DN25	025
DN32	032
DN40	040
DN50	050
DN65	065
DN80	080
DN100	100
DN125	125
DN150	150
DN200	200
DN250	250
DN300	300
DN350	350

BS5156 Length Flanged	
BS10 Table D	F1
BS4504 PN10	F3
ANSI 125/150	F4
JIS 10K	F5
PN10 4-Bolt	F6
Screwed Female	
BS21 Rp	S1
BS21 Rc	S2
API/NPT	S3
DIN Length Flanged	
DIN ND10	D1
DIN ND10-4 Bolt	D2
US Length Flanged	
ANSI 125/150	U1

Cast Iron		SG Iron	
Rubber Diaphragm	CX	Rubber Diaphragm	ZX
PTFE Diaphragm	CW	PTFE Diaphragm	ZW
Butyl Lined	CB	Butyl Lined	ZB
Hard Rubber Lined (HRL)	CC	Hard Rubber Lined (HRL)	ZC
HRL for PTFE	CD	HRL for PTFE	ZD
HRL Full Face	CJ	HRL Full Face	ZJ
HRL Full Face for PTFE	CK	HRL Full Face for PTFE	ZK
Soft Rubber Lined	CS	Soft Rubber Lined	ZS
Neoprene Lined	CN	Neoprene Lined	ZN
Glass Lined	CG	ETFE Lined	ZE
Cast Steel		PFA Lined	ZF
Rubber Diaphragm	QX	PP Lined	ZP
PTFE Diaphragm	QW	PVDF Lined	ZV
Hard Rubber Lined (HRL)	QC	Galvanised	ZZ
HRL for PTFE	QD	Gunmetal	
Stainless Steel		Rubber Diaphragm	GX
Rubber Diaphragm	SX	PTFE Diaphragm	GW
PTFE Diaphragm	SW		

PTFE	
214/300	P1
214/425	P2
214/226	P3
214K/425	P7
214S/425	S5
Fluoroelastomer	
226	V1
Natural Rubber	
AA	A1
Q	A2
Butyl	
300	B1
300 vac	B2
Nitrile	
C	C1
C vac	C2
EPDM	
XA	XA
EPM	
425	E2
425 vac	E6
CSM (formerly Hypalon)	
237	H1
286 fire	H3
Neoprene	
HT	N1

WFB Type Valve

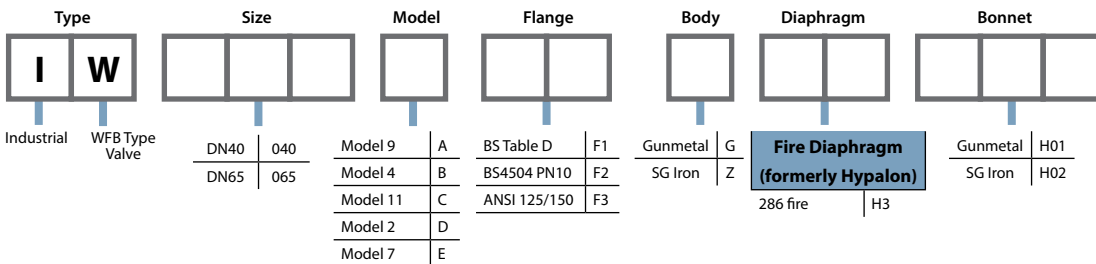

CATALOGUE CODES

Sub Assembly Manual Bonnets Only

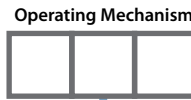
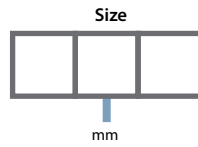
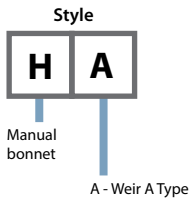

Spares Kits	
Plastic Handwheel	S01
Metal Handwheel	S02
Spindle	S03
Aluminium Compressor	S04
CI Compressor	S05
CI Compressor for 214 diaphragm	S06

Bonnet Description	Rubber Diaphragm	PTFE Diaphragm
RHI — Standard Plastic Handwheel	H01	H02
RHI — Standard Metal Handwheel	H03	H04
RHI — Sealed, with Plastic Handwheel	H07	H08
RHI — Sealed, with Metal Handwheel	H09	H10
RHI — Viton Seal and Padlock	H13	H14
RHI — Padlock and Plastic Handwheel	H15	—
RHI — Padlock and Metal Handwheel/Compressor	H17	H18
RHI — GGG 40.3 Plastic Handwheel	H25	—
RHI — SS/EP PES Handwheel	H26	H24
RHI — GGG 40.3 Metal Handwheel	H27	H28
CI Indicator Bonnet	H33	H34
RHI — SS Sealed EP	H45	H46
Gunmetal LG2	H55	—
Non-Rising Gunmetal LG4 and Padlock	H56	—
Non-Rising Gunmetal LG4 with limit open	H57	—

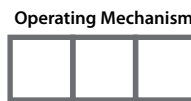
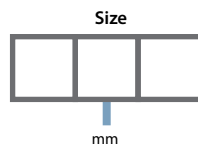
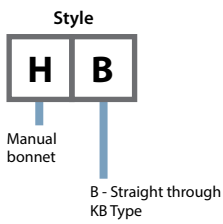

Spares Kits	Code
Plastic Handwheel	S01
Metal Handwheel	S02
Spindle	S03
CI Compressor	S04

Bonnet Description	Code Rubber Diaphragm
RHI — Standard Plastic Handwheel	H01
RHI — Standard Metal Handwheel	H02
CI Indicator Bonnet	H03
RHI — GGG 40.3 Metal Handwheel	H07
Non-Rising Gunmetal LG4 and Padlock	H08

Diaphragm Spares

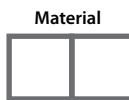
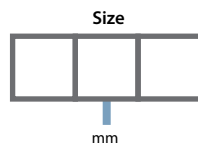
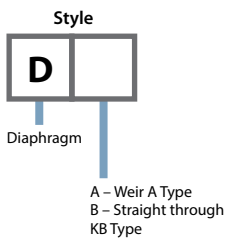

PTFE		Natural Rubber		Butyl	
214/300	P1	AA	A1	300	B1
214/425	P2	Q	A2	300 vac	B2
214/226	P3	Neoprene		Nitrile	
214K/425	P7	HT	N1	C	C1
214S/425	S5	EPDM		C vac	C2
Fluoroelastomer		XA	XA	CSM (formerly Hypalon)	
226	V1	EPM		237	H1
		425	E2	286 fire	H3
		425 vac	E6		



CATALOGUE CODES

Type EC Compact Pneumatic Actuators

Style	Size	Type	Mode of Operation	Diaphragm	Air Connection	Slotted	Limit Stop
A A	<input type="text"/>	C	<input type="text"/>	<input type="text"/>	<input type="text"/>	<input type="text"/>	<input type="text"/>
Diaphragm valve A Type actuator	mm	EC	4 = 4 bar Spring Close 6 = 6 bar Spring Close O = Spring Open D = Double Acting	R = Rubber P = PTFE	B = BSP N = NPT	Y = Yes N = No	N = None O = Limit Open



This side only used when ordering as a spare part.

Type ECX Compact Pneumatic Actuators

Style	Size	Type	Mode of Operation	Diaphragm	Visual Indicator	Limit Stop
A A	<input type="text"/>	X	<input type="text"/>	<input type="text"/>	<input type="text"/>	<input type="text"/>
Diaphragm valve A Type actuator	mm	ECX	F2, F4, G2, G3, G4, G5, H2, H4, H5 = Spring Close OS, OH = Spring Open DS, DH = Double Acting	R = Rubber P = PTFE	Y = Yes N = Only when accessories are used	N = None O = Limit Open



This side only used when ordering as a spare part.

Type EC Actuator OPTI-Set Switchbox Options

Style	Size	Switchbox	OPTI-Set	Conduit Entry	Switch Type	Switch Quantity
V C	<input type="text"/>	B	E	<input type="text"/>	<input type="text"/>	<input type="text"/>
V = Accessory C = EC	mm			O = Metric N = NPT	M1 = V3 Mech. M2 = V3 Mech. Gold Plated M8 = V3 Mech. Gold Plated (ATEX) P2 = ProxSwitch Intrinsically Safe (ATEX) P6 = ProxSwitch 3 Wire NPN P7 = ProxSwitch 3 Wire PNP P8 = ProxSwitch 2 Wire NPN/PNP (5-60Vdc) P9 = ProxSwitch 2 Wire NPN/PNP (5-36Vdc)	Switch Quantity 1 = One 2 = Two



This side only used when ordering as a spare part.

Type EC and ECX Actuators Module Switchbox Options

Style	Size	Switchbox	Module	Conduit Entry	Switch Type	Switch Quantity	Pneumatic Control	Solenoid Voltage
V	<input type="text"/>	B	M	<input type="text"/>	<input type="text"/>	<input type="text"/>	<input type="text"/>	<input type="text"/>
V = Accessory C = EC X = ECX	mm		O = Metric N = NPT P = PG	M1 = V3 Mech. M2 = V3 Mech. Gold Plated M3 = Mech. DPST M8 = V3 Mech. Gold Plated (ATEX) P2 = ProxSwitch Intrinsically Safe (ATEX) P6 = ProxSwitch 3 Wire NPN P7 = ProxSwitch 3 Wire PNP P9 = ProxSwitch 2 Wire NPN/PNP (5-36Vdc)		1 = One 2 = Two		0 = None 1 = 220/240v AC 50/60Hz 2 = 110/120v AC 50/60Hz 3 = 24v DC 4 = Intrinsically Safe 24v DC (ATEX)



This side only used when ordering as a spare part.

EC and ECX Actuators i-Vue Switchbox Options

Style	Size	Switchbox	i-Vue Protocol	Solenoid	Elect. Connector	Cable Options
V	<input type="text"/>	B	I	<input type="text"/>	<input type="text"/>	<input type="text"/>
V = Accessory C = EC X = ECX	mm		2E2 = Point to Point A31 = ASI v2.0 A32 = ASI v2.1 DNB = DeviceNet	0 = not required 1 = Aluminium (BSp) 2 = S. Steel (BSp) 3 = Aluminium (NPT) 4 = S. Steel (NPT)	1 = M12 2 = Mini 7/8" 5pin 3 = Cable Gland 4 = Flat Cable	0 = not required [Contact Saunders for details of cable options]



This side only used when ordering as a spare part.

CATALOGUE CODES

Type ES Modular Valve Actuator

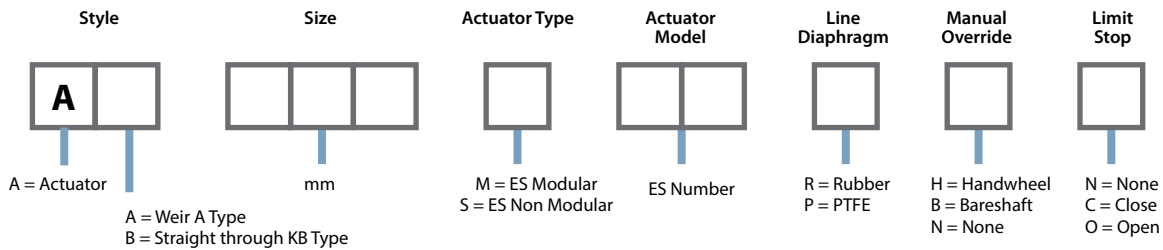

Type ES Modular Actuator 007 Switchbox Options

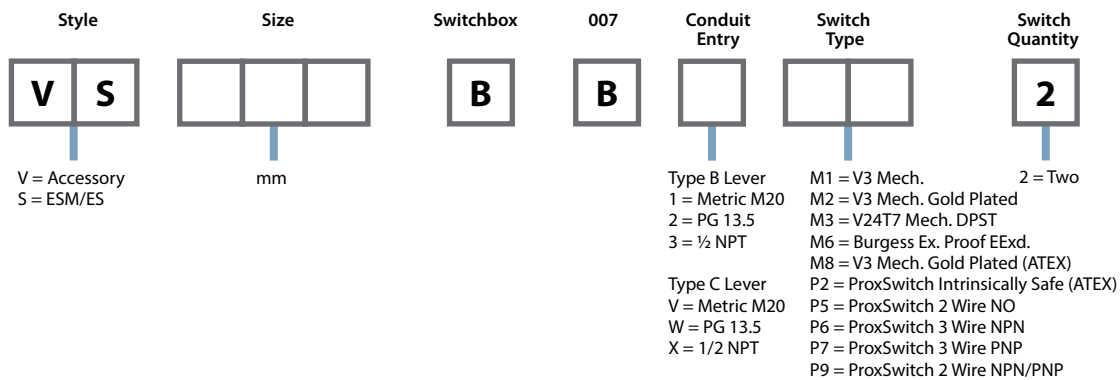

Type ES Actuator Positioner Options

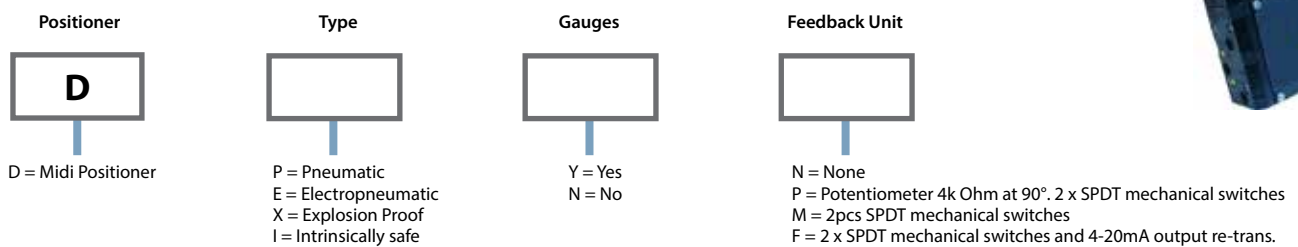

Type ES Actuator Operating Diaphragm Spares

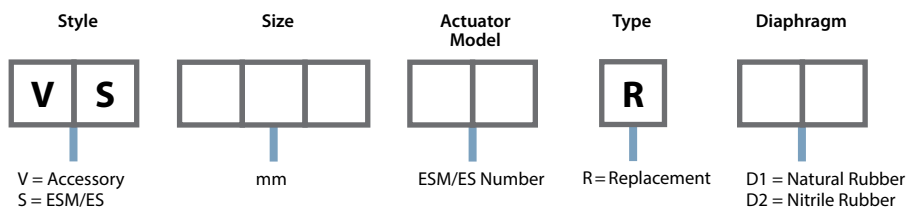



Crane ChemPharma & Energy

Crane Process Flow Technologies Ltd.

Grange Road

Cwmbran, Gwent NP44 3XX

UNITED KINGDOM

Tel: +44 1633 486666

Fax: +44 1633 486777

www.cranecpe.com



Crane Process Flow Technologies
SPRL / BV
Avenue Franklin No. 1
Wavre, B-1300 , Belgium
Tel: +32 10 8184 44
Fax: +32 10 8184 58

Crane ChemPharma & Energy
Headquarters
4444 Cooper Road
Cincinnati, Ohio 45242
Tel: 513-745-6000
Fax: 513-745-6086

Crane Process Flow Technologies (India) Ltd
Solitaire, 5th & 6th Floor, S.No. 131 / 1+2 ,
ITI Road, Aundh, Pune - 411007, India
Tel: +91 20 3056 7800
Fax: +91 20 3056 7812



brands you trust.



COMPAC-NOZ



DEPA

ELRO Duo-CHEK



NOZ-CHEK



RESISTOFLEX



STOCKHAM



UNI-CHEK

w.ta.

XOMOX

CPE-SAUNDERS IDV 24PG-BU-EN-A4-2015_09_09

Crane Co., and its subsidiaries cannot accept responsibility for possible errors in catalogues, brochures, other printed materials, and website information. Crane Co. reserves the right to alter its products without notice, including products already on order provided that such alteration can be made without changes being necessary in specifications already agreed. All trademarks in this material are property of the Crane Co. or its subsidiaries. The Crane and Crane brands logotype, in alphabetical order, (ALOYCO, CENTER LINE, COMPAC-NOZ, CRANE, DEPA, DUO-CHEK, ELRO, FLOWSEAL, JENKINS, KROMBACH, NOZ-CHEK, PACIFIC VALVES, RESISTOFLEX, REVO, SAUNDERS, STOCKHAM, TRIANGLE, UNI-CHEK, WTA, and XOMOX) are registered trademarks of Crane Co. All rights reserved.